

 **MISUTONIDA**
  *italian style* **4x4**
accessories

TOYOTA HI-LUX DOUBLE CAB



Item Code

Codice Articolo

Référence Article

GP/208/IX
:
GPO/208/IX

GB

**STAINLESS STEEL GRAND PEDANA
OVAL GRAND PEDANA**









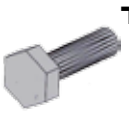

ITA

**GRAND PEDANA/ GRAND PEDANA
OVALE IN ACCIAIO INOX**

FR

**GRAND PEDANA/ GRAND
PEDANA OVALE EN ACCIER INOX**

TOYOTA HI-LUX DOUBLE CAB

Part List Lista della bulloneria Liste des pièces	
A  TE 10X50 Black Nero Noir x 4	I  S/171/A-SX x 1
B  M10 autoblocking autobloccante autobloquant x 4	L  S/171/A-DX x 1
C  TE 8X20 x 6	
D  Ø 8 x 8	
E  Ø 8 x 8	
F  M8 x 2	
G  S/171/P-SX x 1	
H  S/171/P-DX x 1	

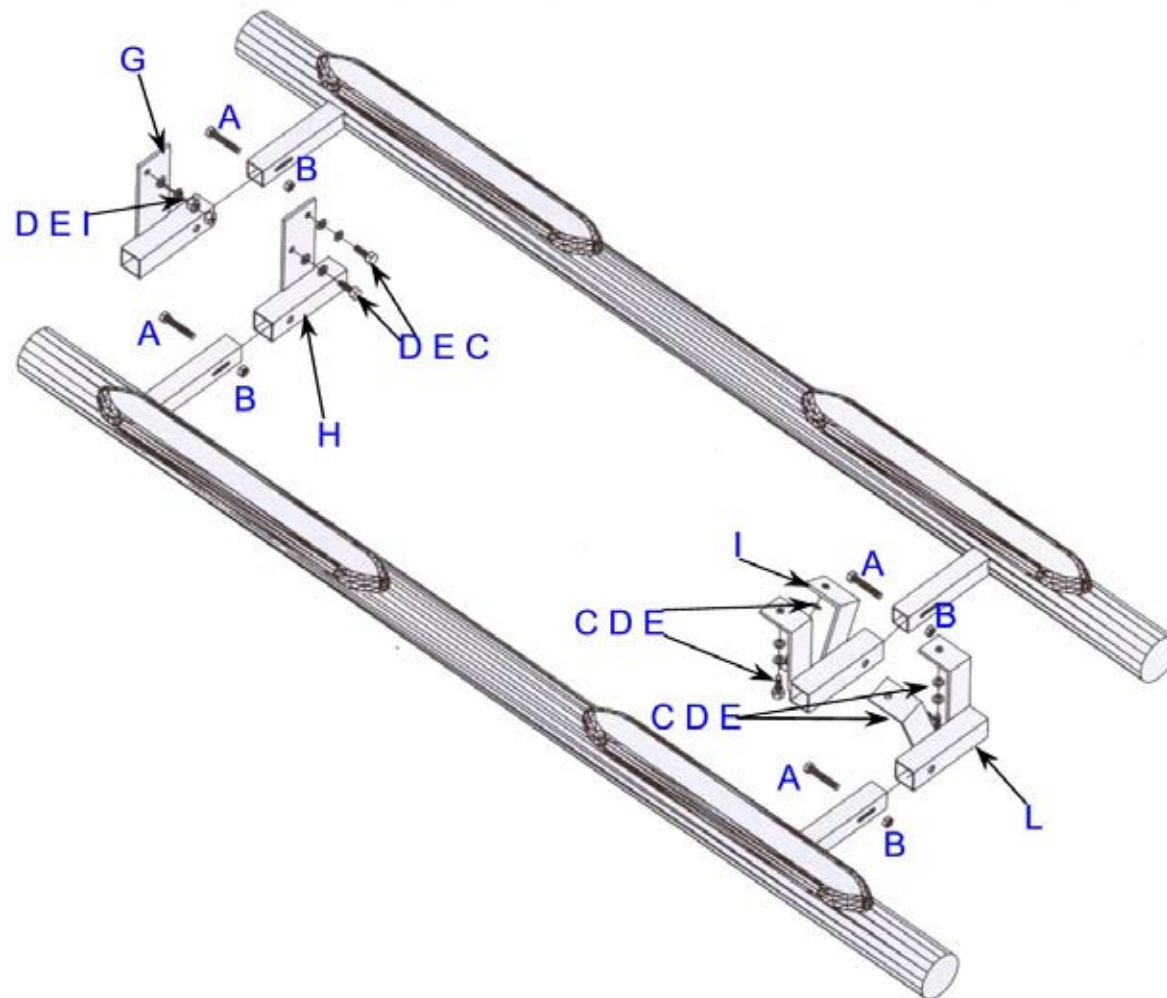

 **MISUTONIDA**
  *italian style* **4x4**
accessories



Date Data Date	Item Code Cod.Articolo Réf. Article	Vehicle model Modello Veicolo Modèle de Voiture
28/09/07	GP/208/IX GPO/208/IX	TOYOTA HI-LUX 2006 DOUBLE CAB

Checked and approved by
Controllato ed approvato da
Controlé et approuvé par

**Claudio
 Gallo**

 **MISUTONIDA**
italian style accessories **4x4**