

2

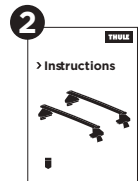

# > Instructions

Thule Evo Clamp  
710500

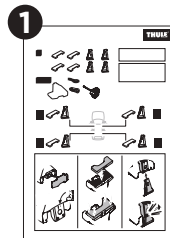
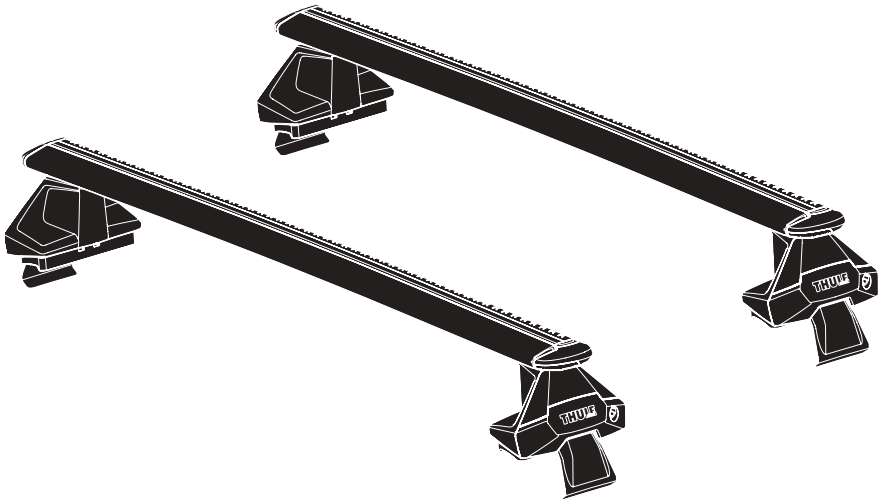

**EN** Roof mounted load carrier  
**DE** Lastenträger zur Dachmontage  
**FR** Barre de toit  
**NL** Dakdrager  
**IT** Barra portatutto da installare sul tetto  
**ES** Portaequipajes de techo  
**PT** Barra para montagem no tejadilho  
**SV** Takmonterad lasthållare  
**DK** Tagmonteret lastholder  
**NO** Takmontert lasteholder  
**FI** Katolle asennettava teline  
**ET** Katusele paigaldatav katuseraam  
**LV** Uz jumta uzstādāms kravas turētājs  
**LT** Ant stogo tvirtinamas krovinų laikiklis  
**PL** Uchwyt na bagażnik bazowy montowany na dachu  
**RU** Багажник на крышу  
**UK** Багажник для даху  
**BG** Багажник, монтиран върху покрива  
**CS** Nosič pro montáž na střechu  
**SK** Strešný nosič  
**SL** Nosilec za strešni prtljažnik  
**HR/BIH** Krovni nosač tereta

**RO** Suport încercătură montat pe acoperiș  
**HU** Tetőre szerelhető csomagszállító  
**EL** Στήρα οροφής για μεταφορά φορτίου  
**TR** Araç üstüne bağlanan yük taşıyıcı  
**HE** מנשא מטען לגג הרכב  
**AR** حامل نقل مثبت على السقف  
**ZH** 顶置行李架  
**JA** ルーフマウント型ロードキャリア  
**KO** 루프 장착 화물 캐리어  
**TH** โครงยึดของบรรทุกแบบติดตั้งบนหลังคา

**CITY CRASH**  
Complies with ISO norm

ISO 11154-E

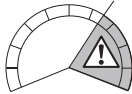
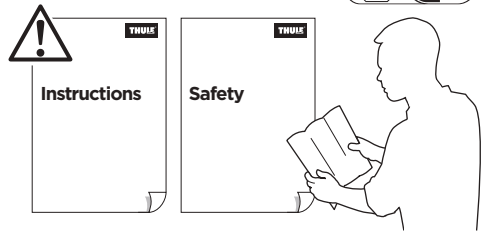

Max 130 km/h  
80 Mph



Your Key-Number

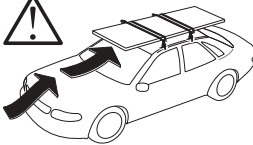

80 km/h  
50 Mph

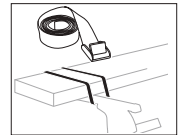
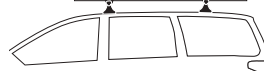
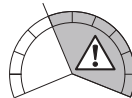

## > Mounting Tutorial

### Thule Evo Clamp

**THULE**  
SWEDEN



thule.com

**1**  
KIT

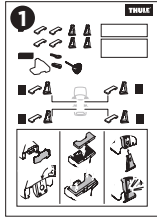

+

**2**  
FOOT PACK

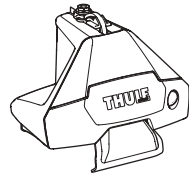
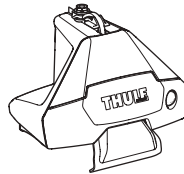
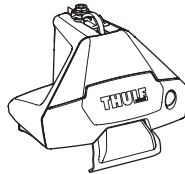
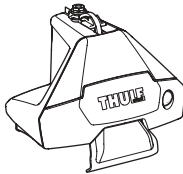
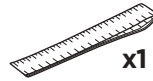
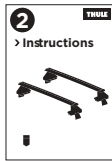

**3**  
BAR



THULE  
WingBar Evo

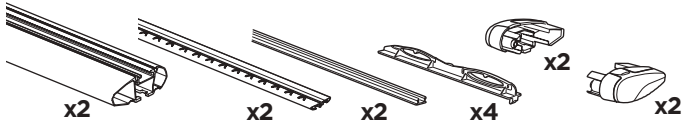

THULE  
WingBar

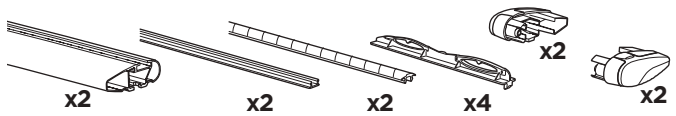

THULE  
SlideBar Evo

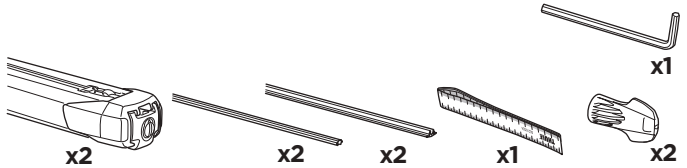

THULE  
ProBar Evo

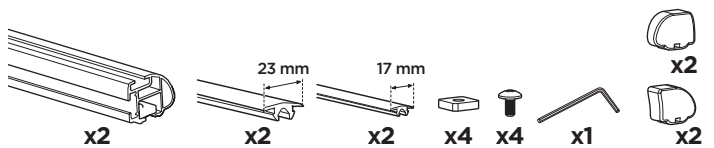

THULE  
SquareBar Evo

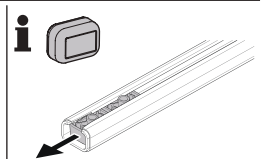
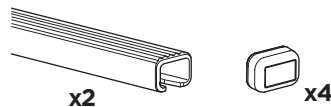



THULE  
WingBar Evo



A

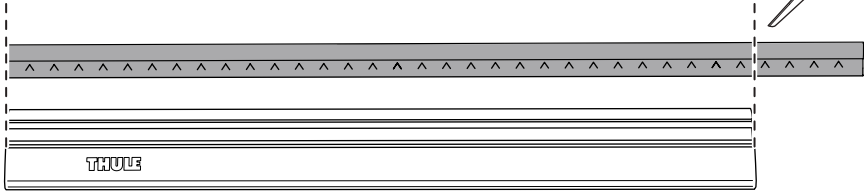

B

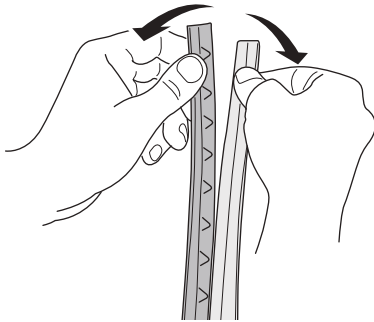

C

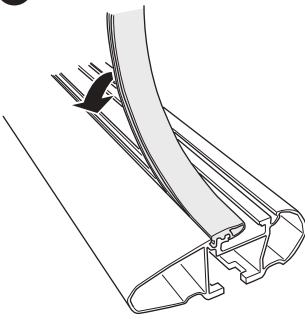

D

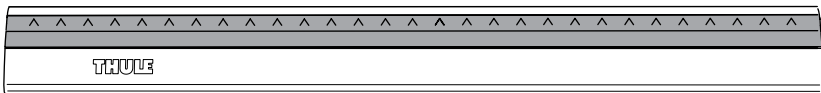
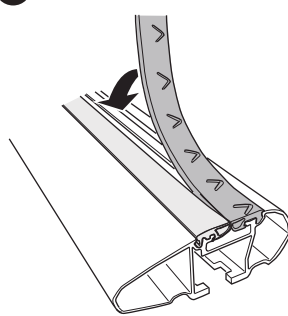

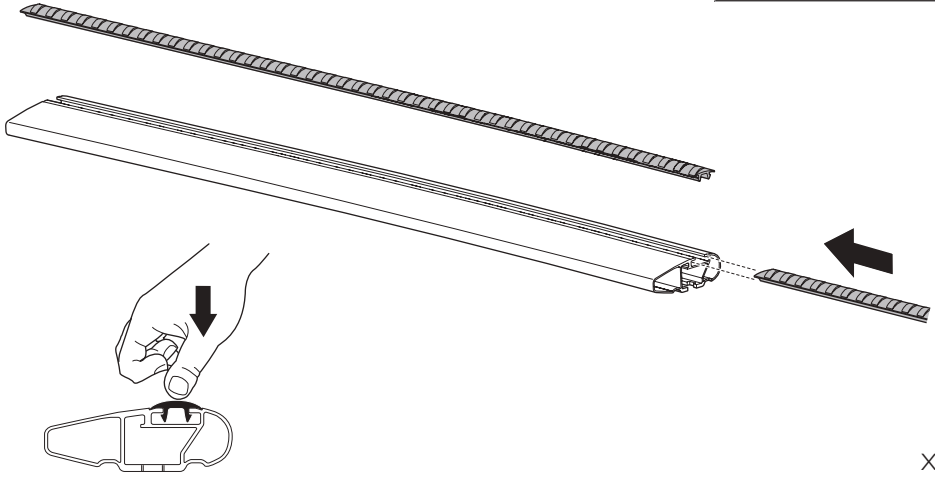

5



A



B



C

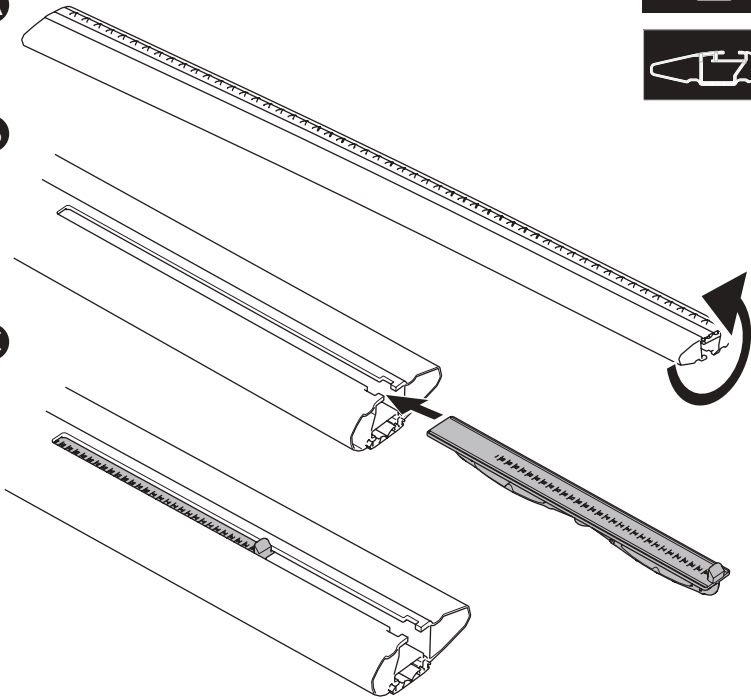

6

**1** KIT + **2** FOOT PACK + BAR **3**

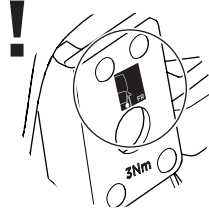
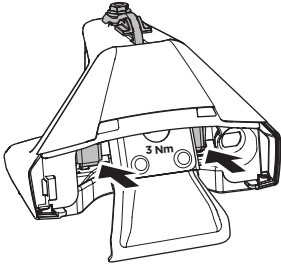

**A**

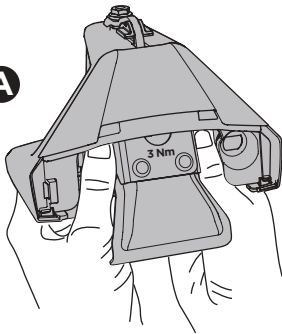

**B**

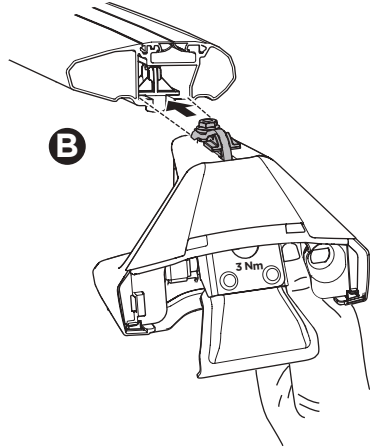

x4

7

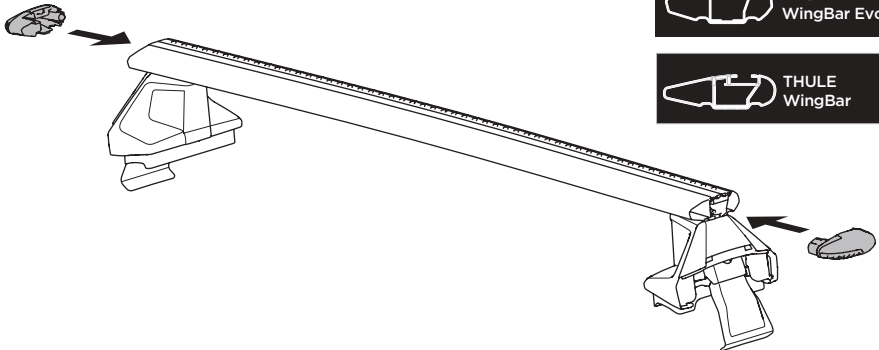

x2

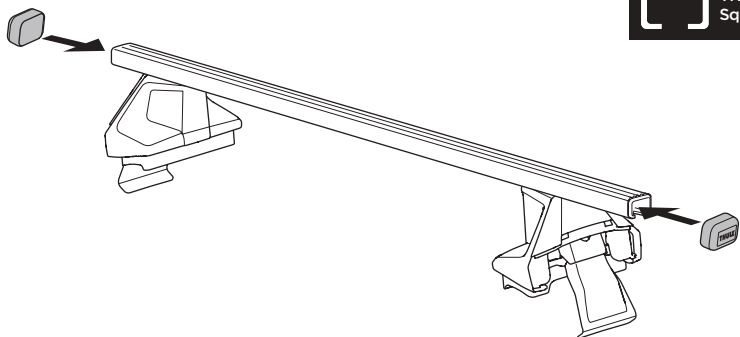

 THULE  
SquareBar Evo

x2

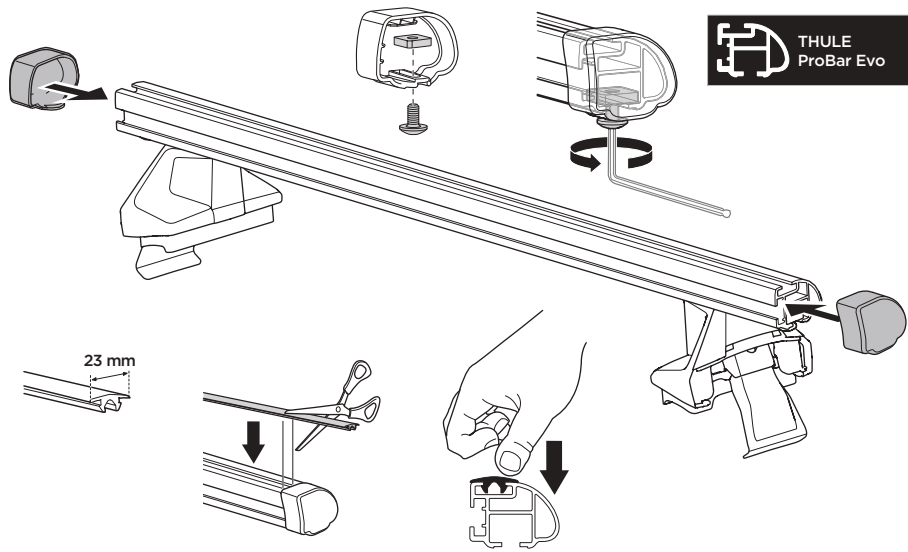

 THULE  
ProBar Evo

x2

 THULE  
SlideBar Evo

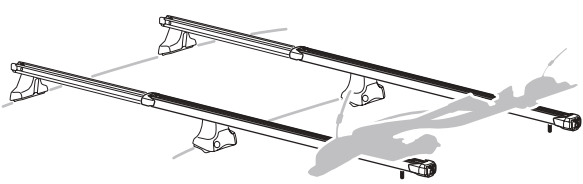

8

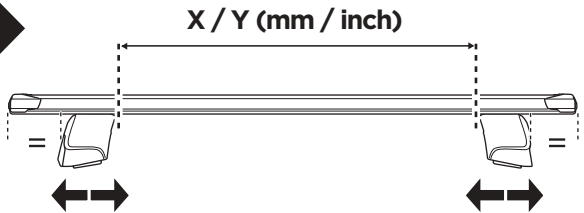
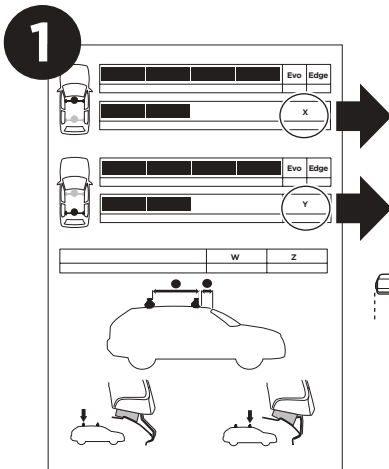
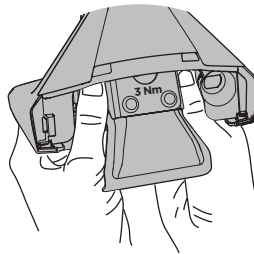
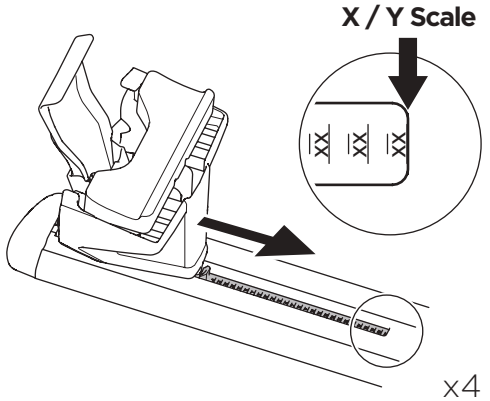
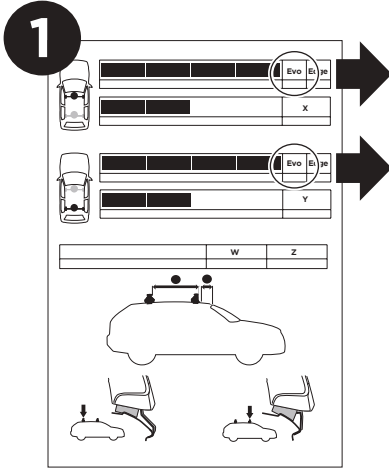
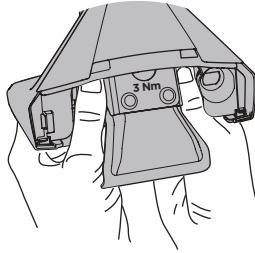

x2



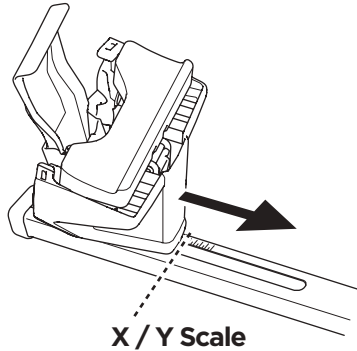
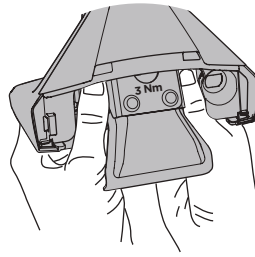
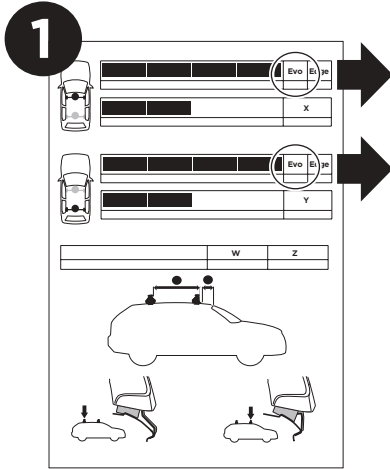

x4

**9**

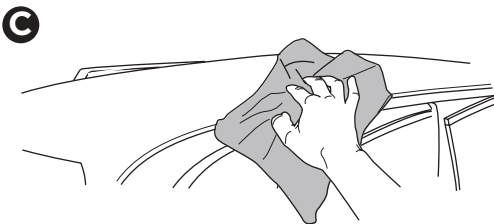
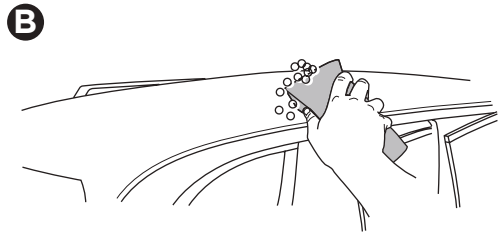
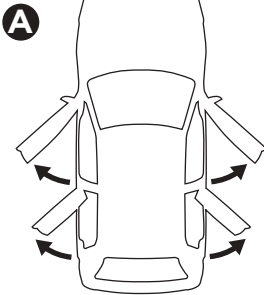

10

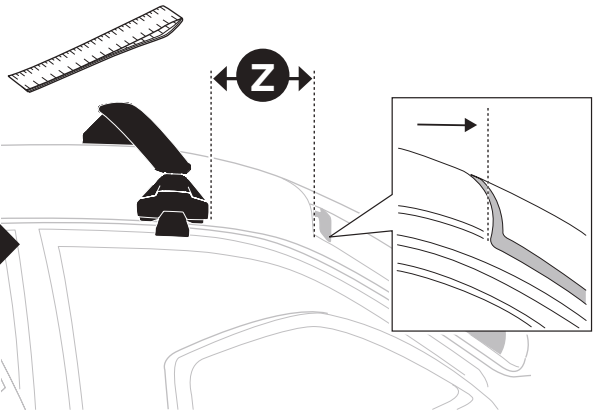
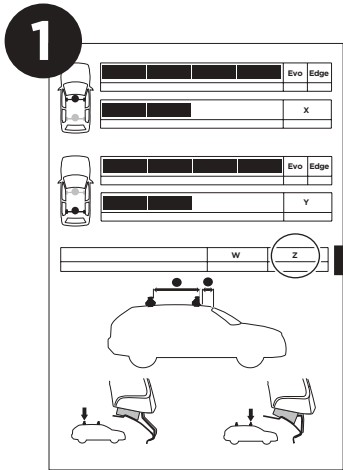
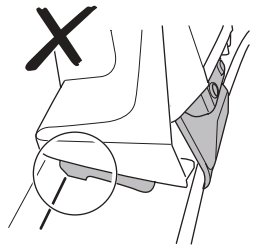
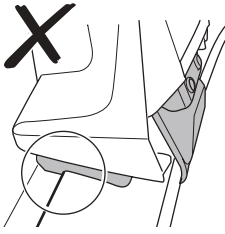
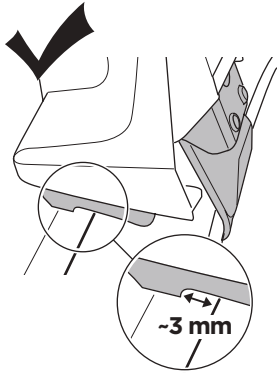
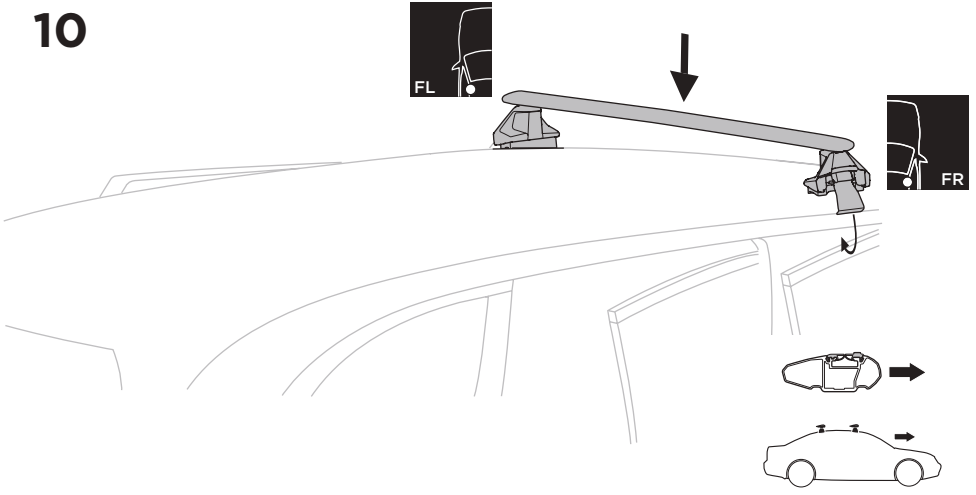

11

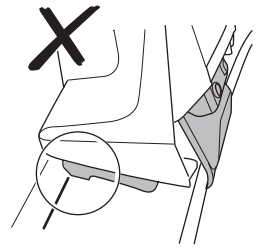
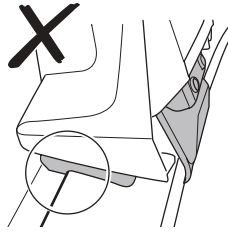
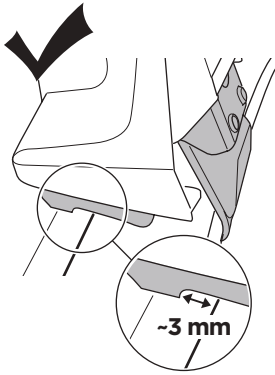
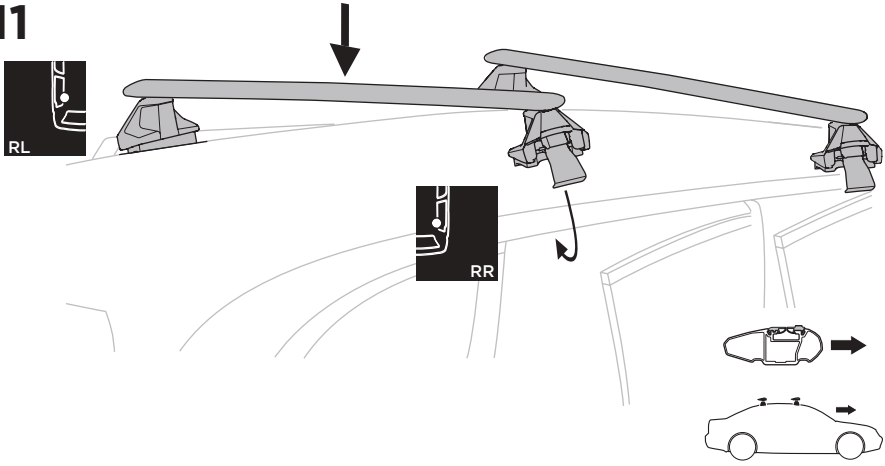

**1**

		Evo	Edge
		X	
		Evo	Edge
		Y	

W      Z

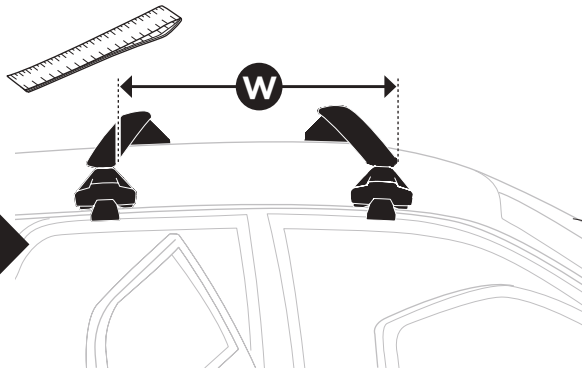

12

-50%

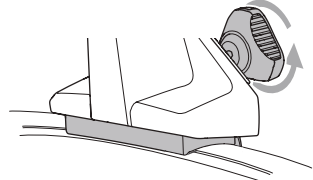
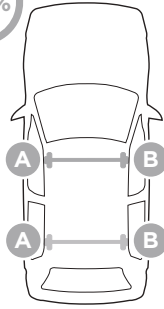
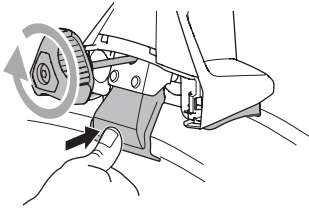

100%

Click  
Click

3 Nm

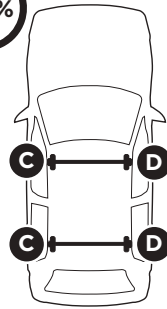
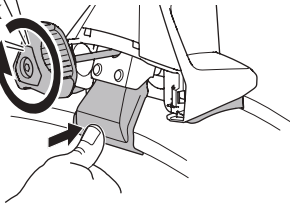

Click  
Click

3 Nm

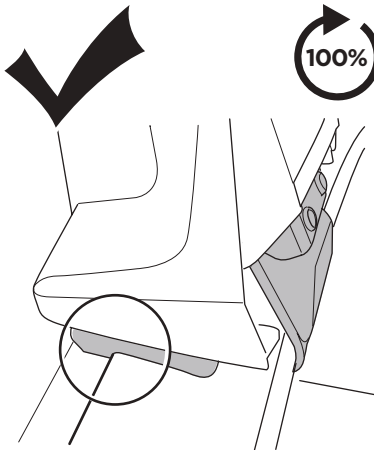
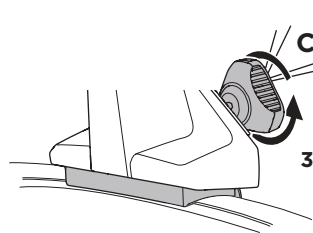

100%

1

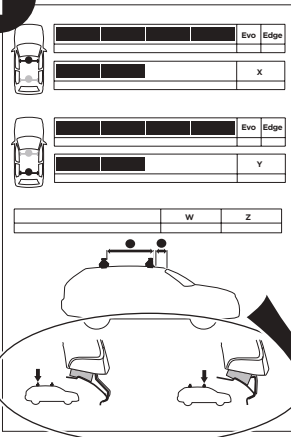

13

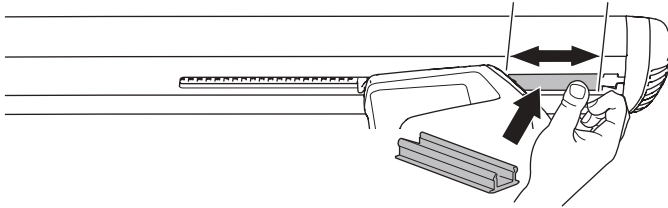
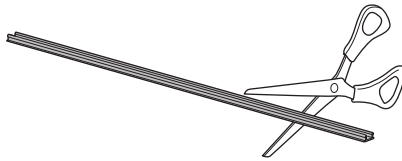

x4

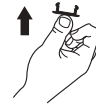
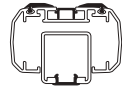
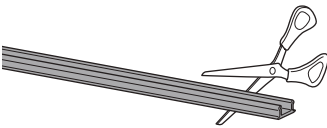
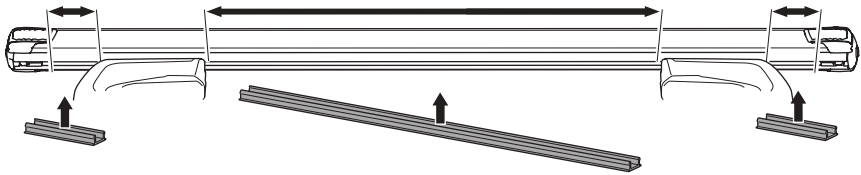

x2

17 mm

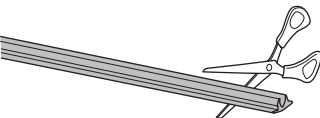
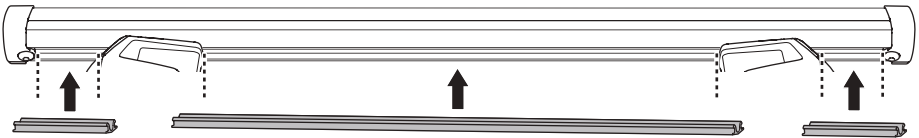
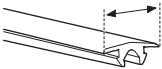

x2

14

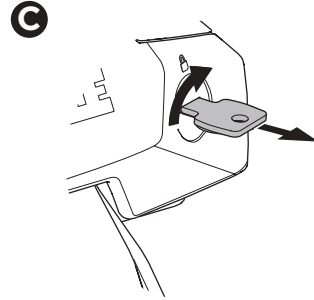
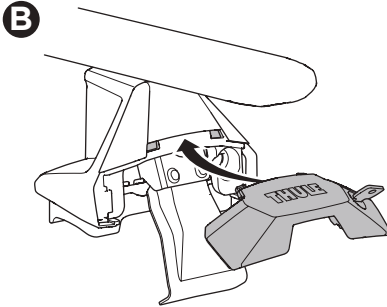
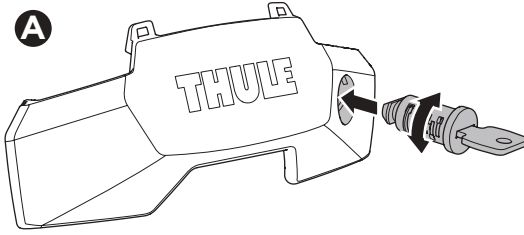

x4

15

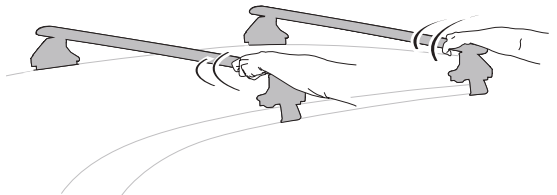
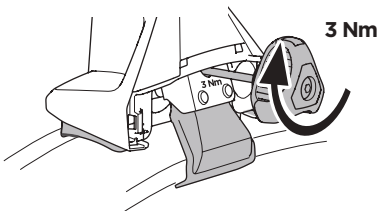
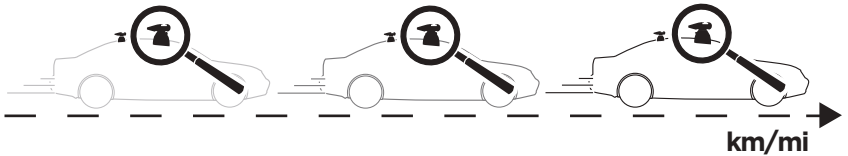
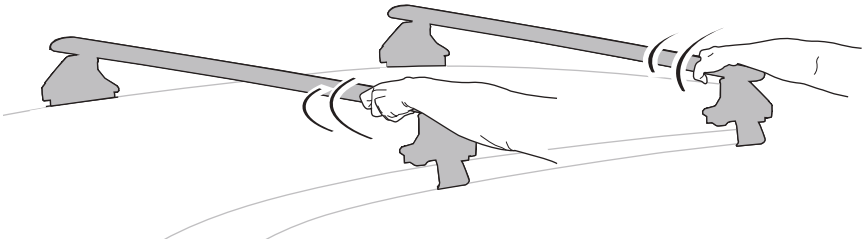

**i**

