

2

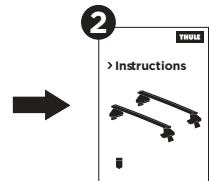

> Instructions

Thule Evo Clamp
710500

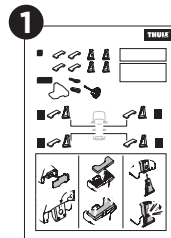
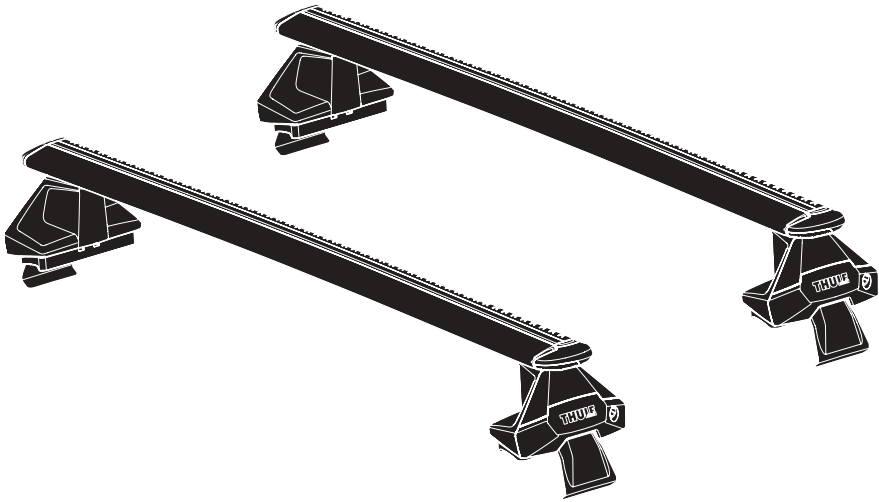

EN Roof mounted load carrier
DE Lastenträger zur Dachmontage
FR Barre de toit
NL Dakdrager
IT Barra portatutto da installare sul tetto
ES Portaequipajes de techo
PT Barra para montagem no tejadilho
SV Takmonterad lasthållare
DK Tagmonteret lastholder
NO Takmontert lasteholder
FI Katolle asennettava teline
ET Katusele paigaldatav katuseraam
LV Uz jumta uzstādāms kravas turētājs
LT Ant stogo tvirtinamas krovinų laikiklis
PL Uchwyt na bagażnik bazowy montowany na dachu
RU Багажник на крышу
UK Багажник для даху
BG Багажник, монтиран върху покрива
CS Nosič pro montáž na střechu
SK Strešný nosič
SL Nosilec za strešni prtljažnik
HR/BIH Krovni nosač tereta

RO Suport încărcătură montat pe acoperiș
HU Tetőre szerelhető csomagszállító
EL Σχάρα οροφής για μεταφορά φορτίου
TR Araç üstüne bağlanan yük taşıyıcı
HE מנשא מטען לגג הרכב
AR حامل نقل مثبت على السقف
ZH 顶置行李架
JA ルーフマウント型ロードキャリア
KO 루프 장착 화물 캐리어
TH โครงยึดของบรรทุกแบบติดตั้งบนหลังคา

CITY CRASH
Complies with ISO norm

ISO 11154-E

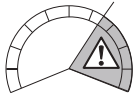
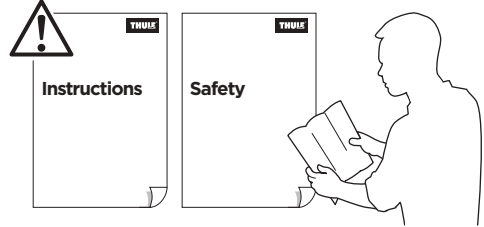

Max 130 km/h
80 Mph



Your Key-Number

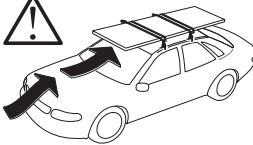

80 km/h
50 Mph

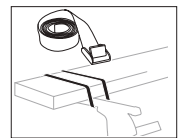
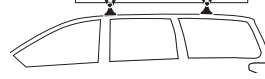

> Mounting Tutorial

Thule Evo Clamp

THULE
SWEDEN



thule.com

1
KIT

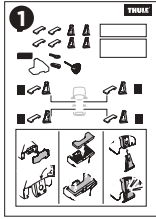

+

2
FOOT PACK

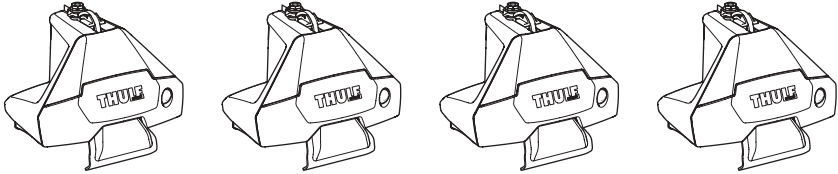
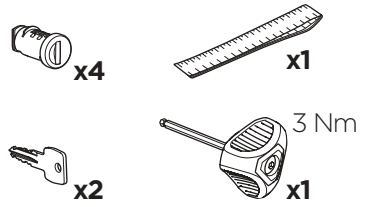
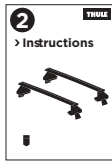

3
BAR

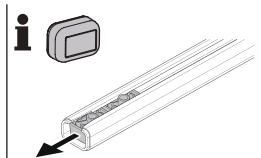
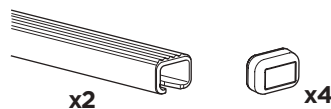
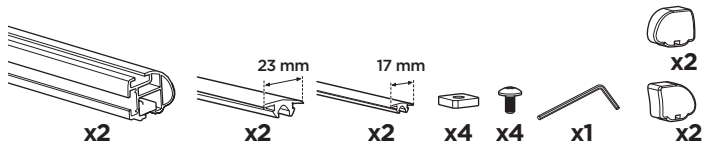
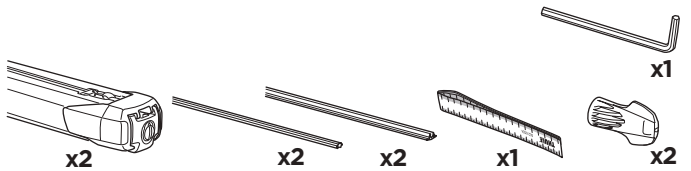
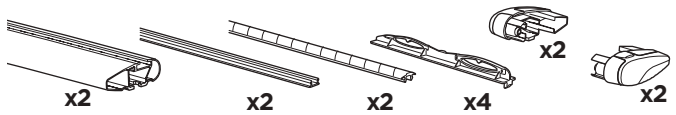
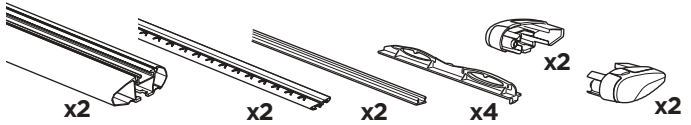



A

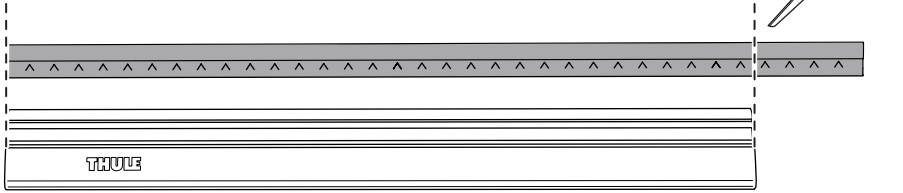

B

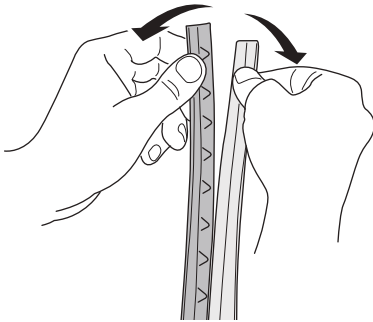

C

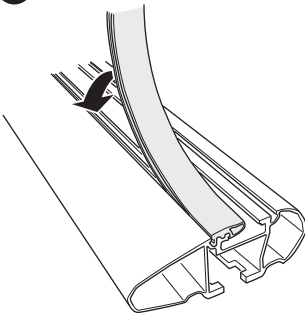

D

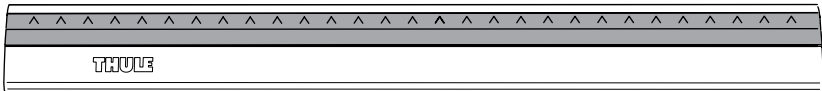
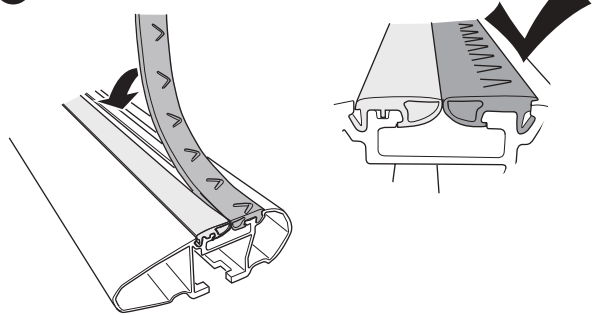

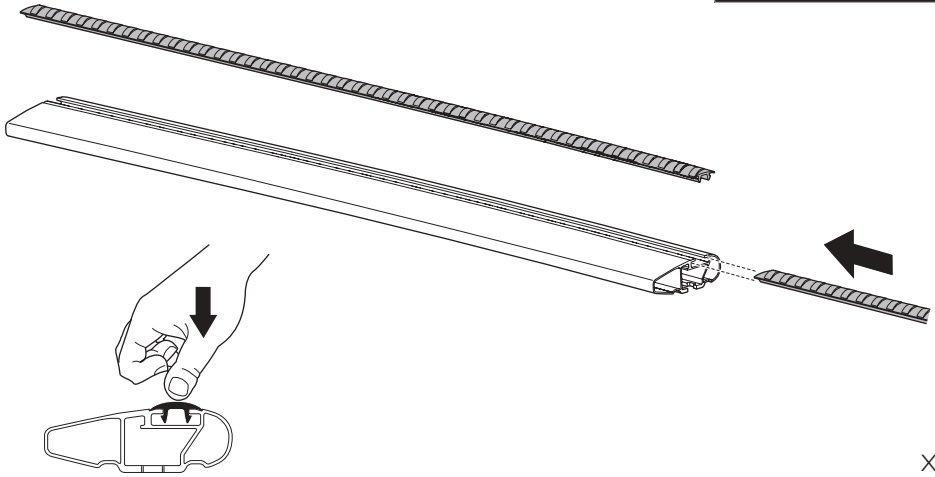

5



A



B



C

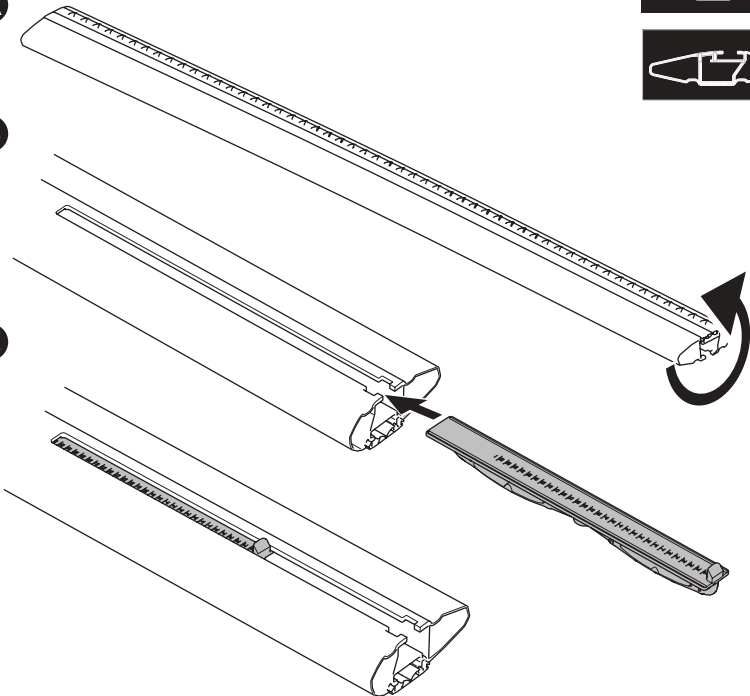

6



+



+

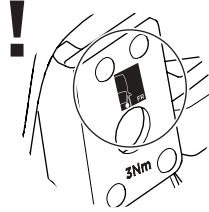
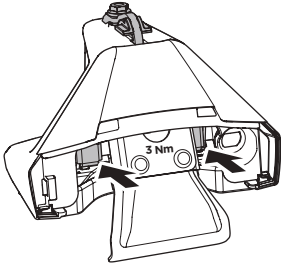

A

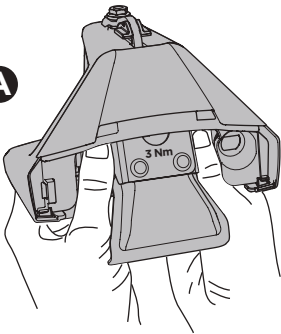

B

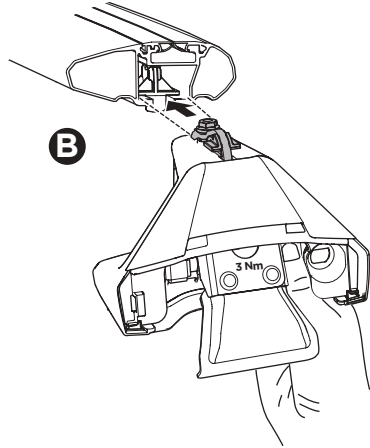

x4

7

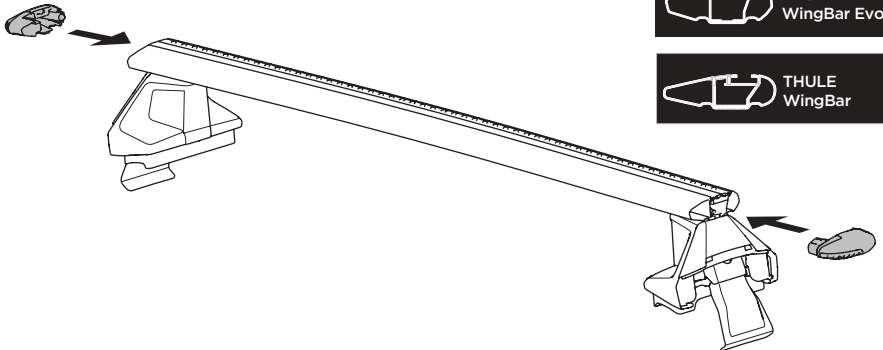

x2

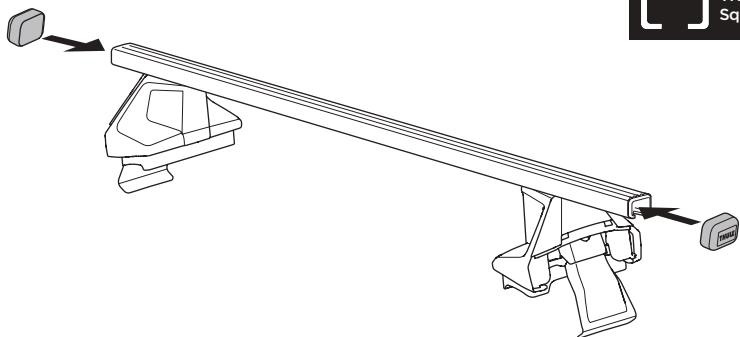

THULE
SquareBar Evo

x2

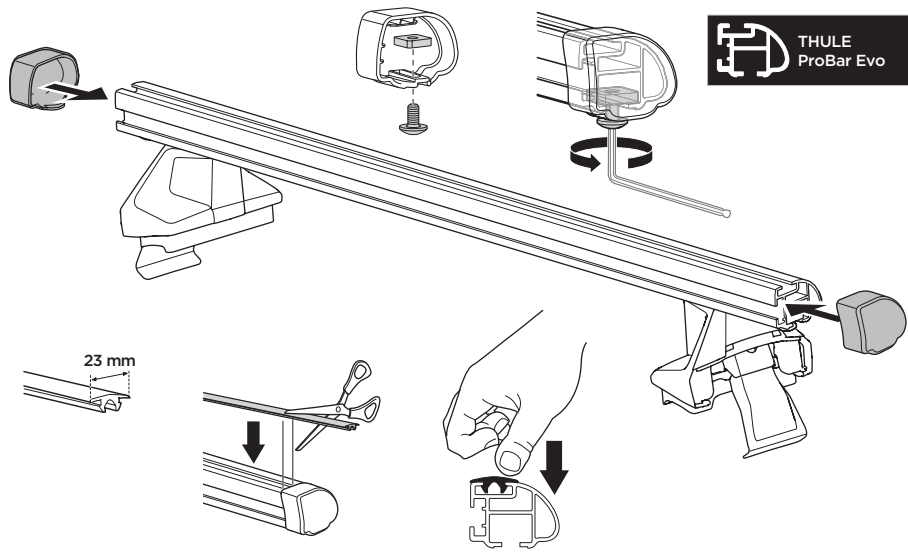

THULE
ProBar Evo

x2

THULE
SlideBar Evo

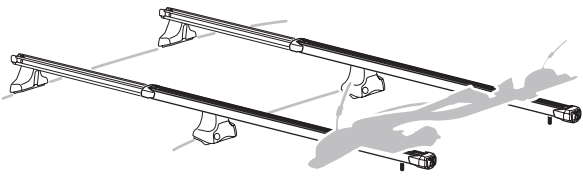

8

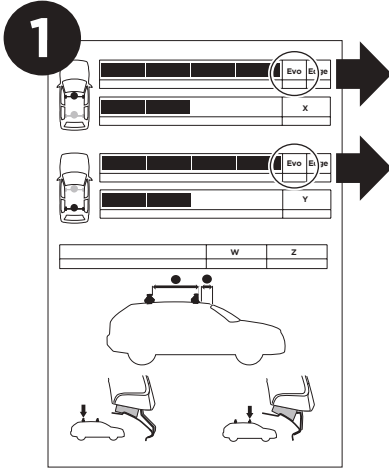
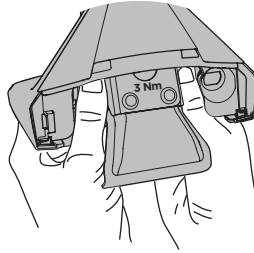

X / Y Scale

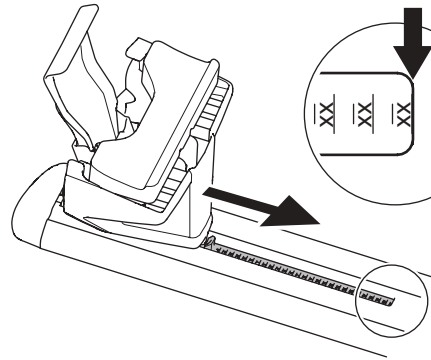
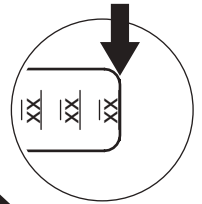

x4

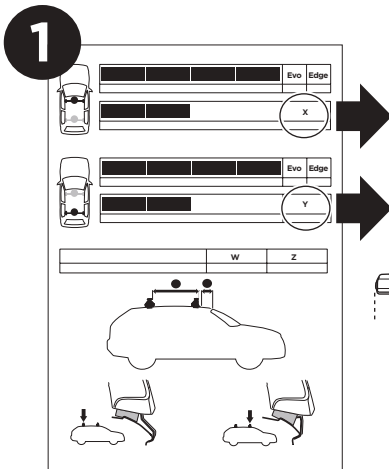
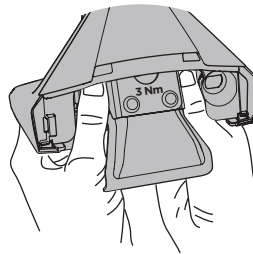

X / Y (mm / inch)

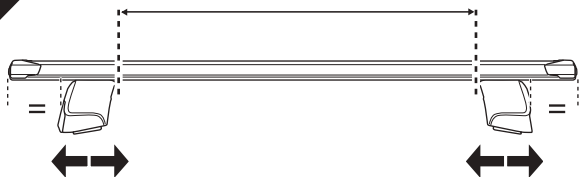

x2

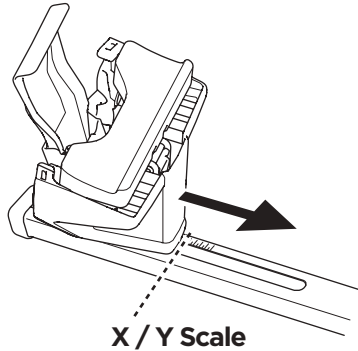
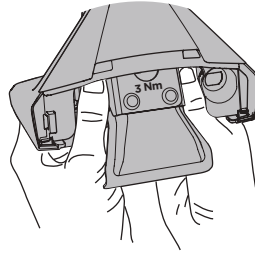
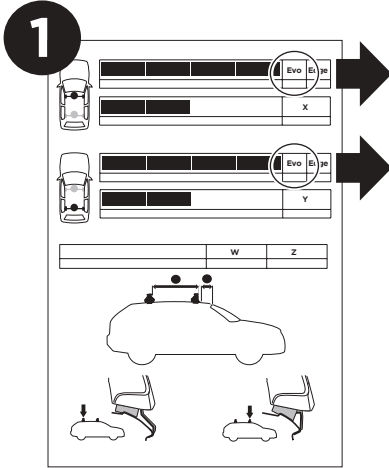

x4

9

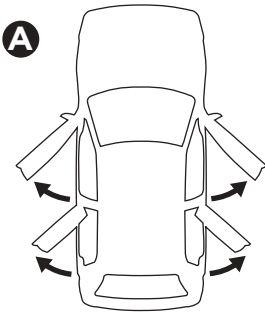

B

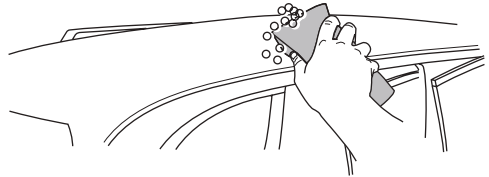

C

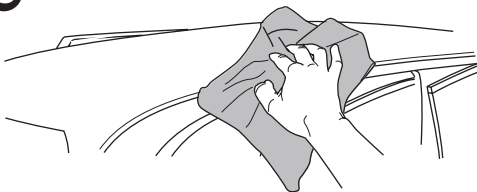

10

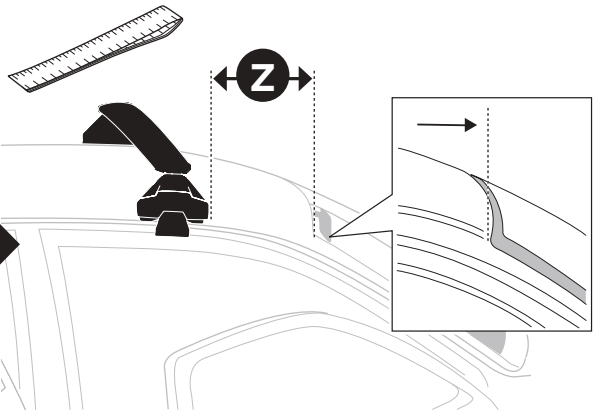
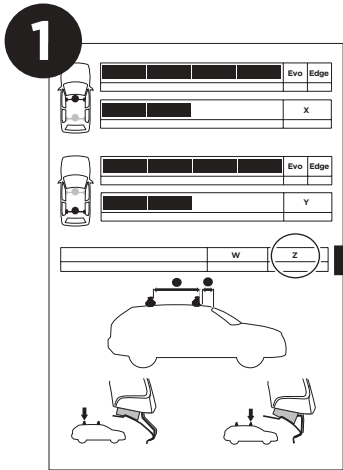
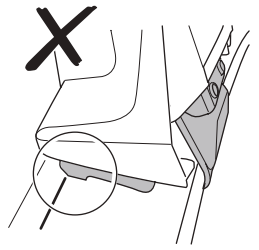
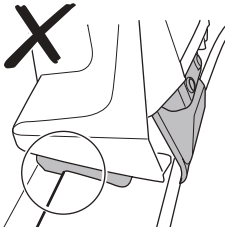
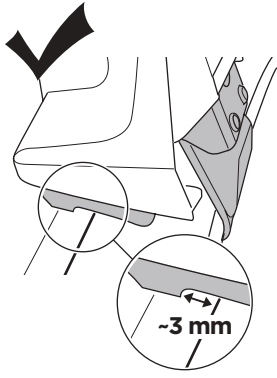
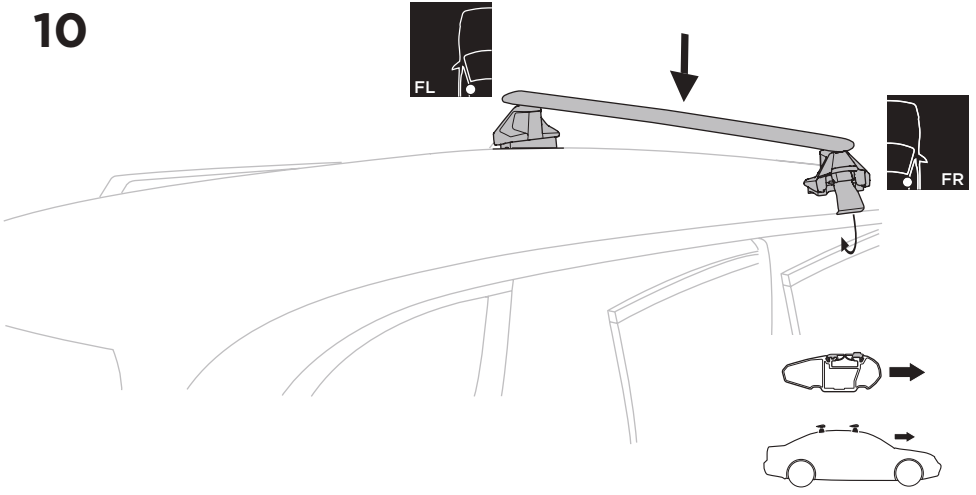

11

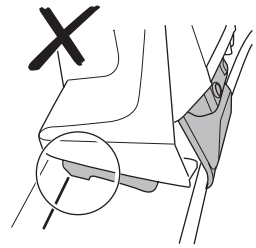
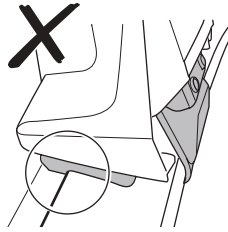
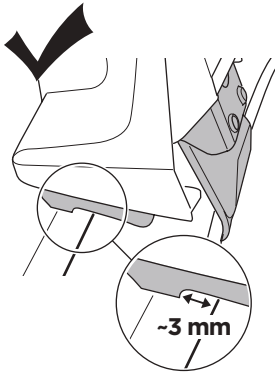
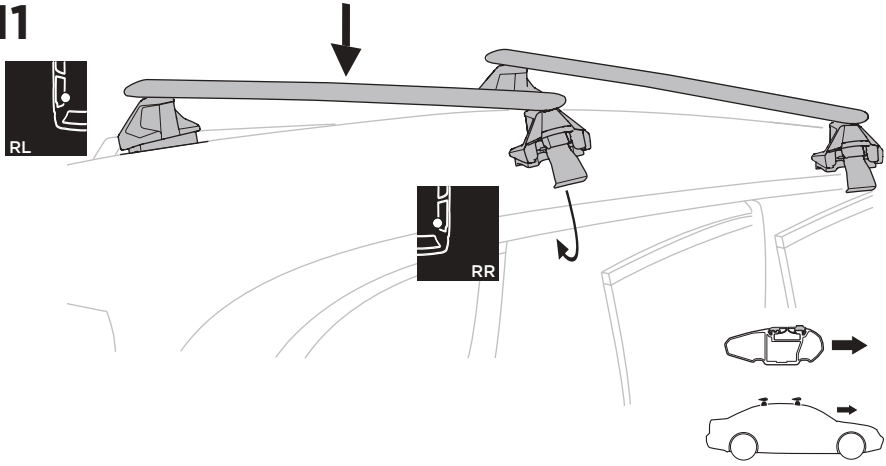

1

		Evo	Edge
		X	
		Evo	Edge
		Y	

W Z

12

-50%

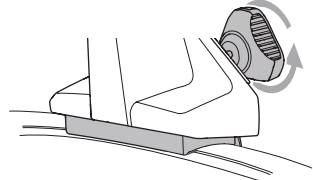
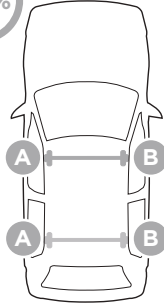
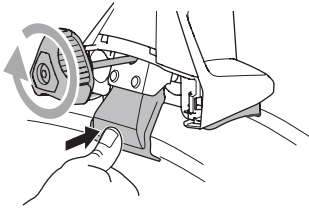

100%

Click
Click

3 Nm

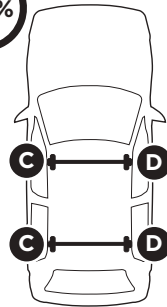
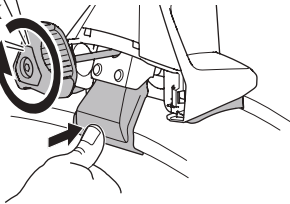

Click
Click

3 Nm

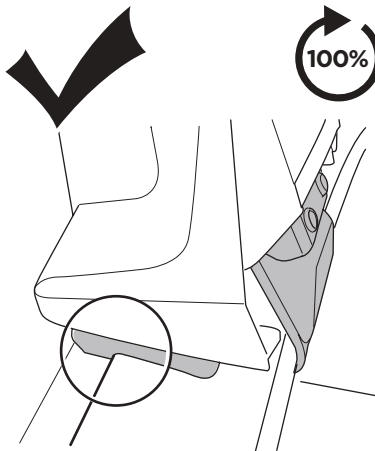
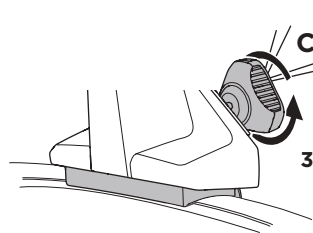

1

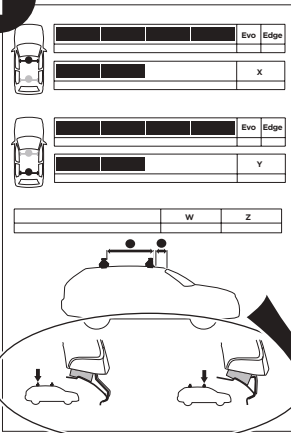

13

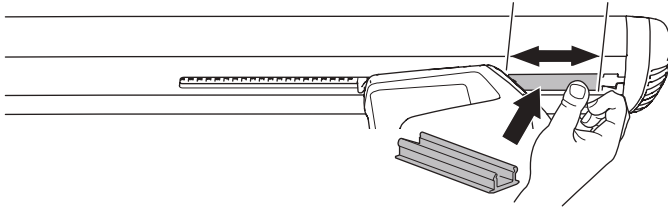
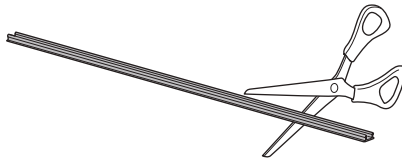

x4

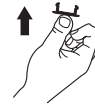
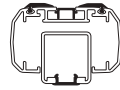
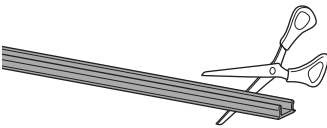
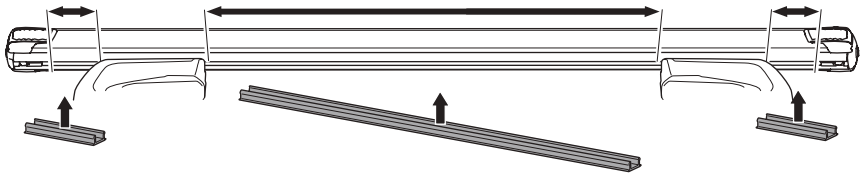

x2

17 mm

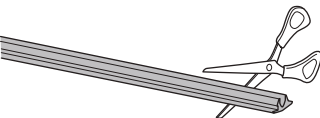
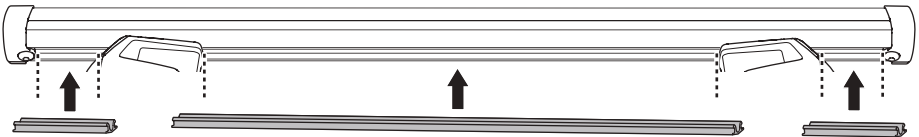
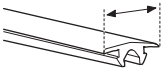

x2

14

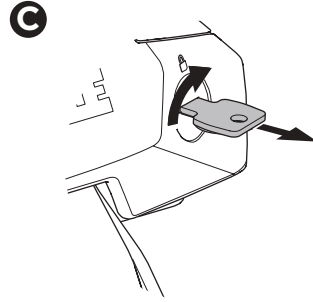
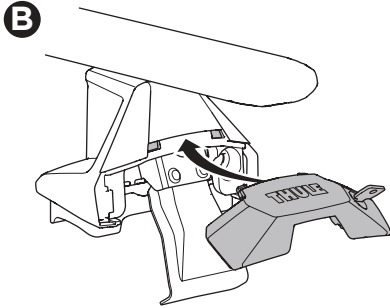
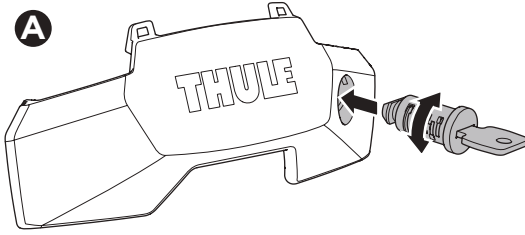

x4

15

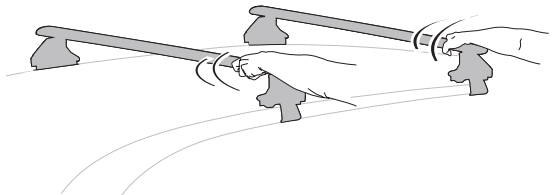
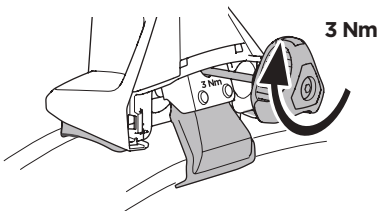
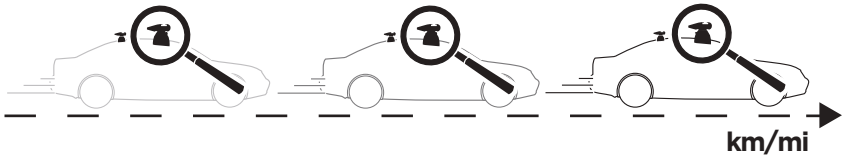
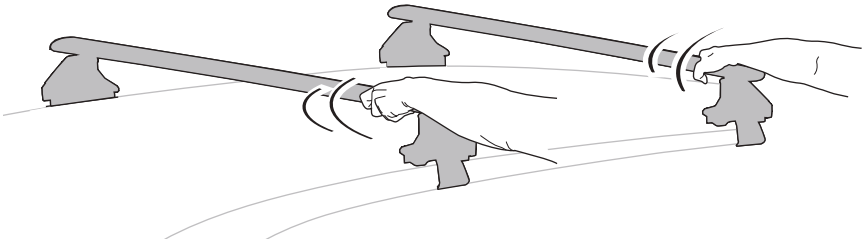

i



THULE
WingBar Evo

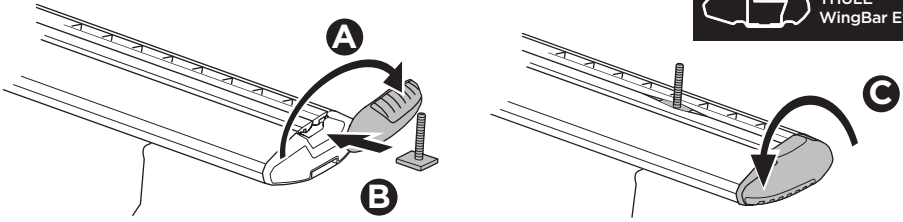

THULE
WingBar

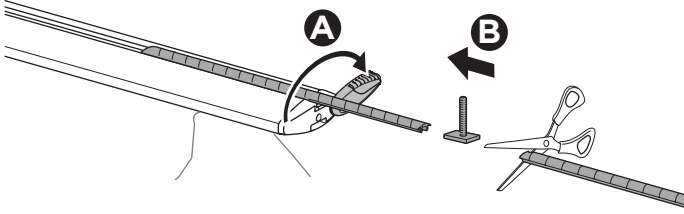

THULE
SlideBar Evo

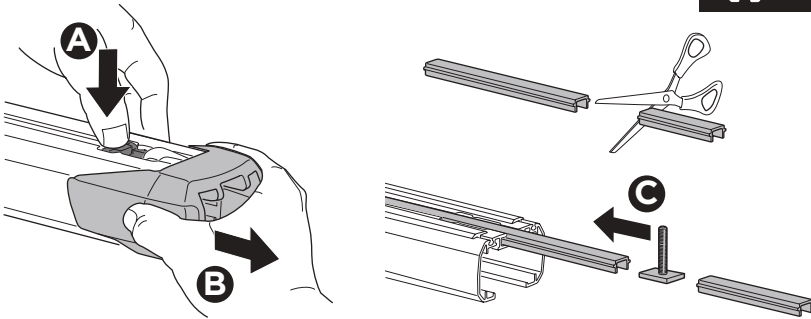

THULE
ProBar Evo

